

Introduction To:



ISO 9001

AS 9100



Presented By: New Age Manufacturing Sales

Experienced Bearing Distributor

- Established 1982
- 30+ years – Authorized bearing distributor & re-lube facility
- Specialize – Miniature and Instrument bearings
- Specialize – Aerospace bearings
- Specialize – Unique “hard to find” bearings
- Average years of employee service – 10
- Quality Management System – ISO9001:2015 and AS9100 Rev D certified



When Your Vendors Experience and Product Knowledge are Essential for Business, You Can Count On IBSCO To Deliver !

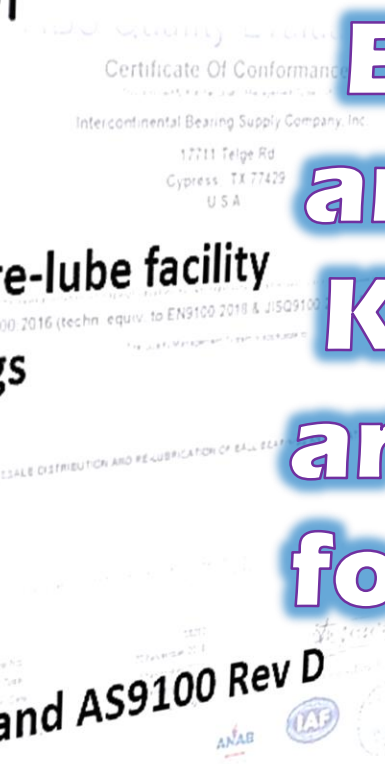

Product Offering

- **Wide array of bearing products stocked and sourced:**
 - **Miniature & Instrument Bearings**
 - **Ball, Roller & Needle Bearings**
 - **Aerospace Bearings – Airframe Control, Spherical & Rod Ends**
 - **Spherical Bearings – PTFE Lined & Metal to Metal**
 - **Rod End Bearings – PTFE Lined, Metal to Metal & Rolling Element**
 - **Journal Bearings – PTFE Lined, Oil Impregnated Bronze, Stainless & Aluminum**
 - **Linear Motion Products**
 - **Staking Tools**
 - **Hybrid bearings – Full Ceramic or Ceramic Balls**

NIMB



AURORA



Koyo

TIMKEN



NACHI

IKO



SMT

NTN



KYK

IJK

KSK

**IBSCO
Stocks and
Sources These
Major Brands
and Many
More to Make
Sure We Can
Meet and
Supply All
of Your
Requirements**

IBSoco

Aerospace

Custom Solutions for Advanced Application

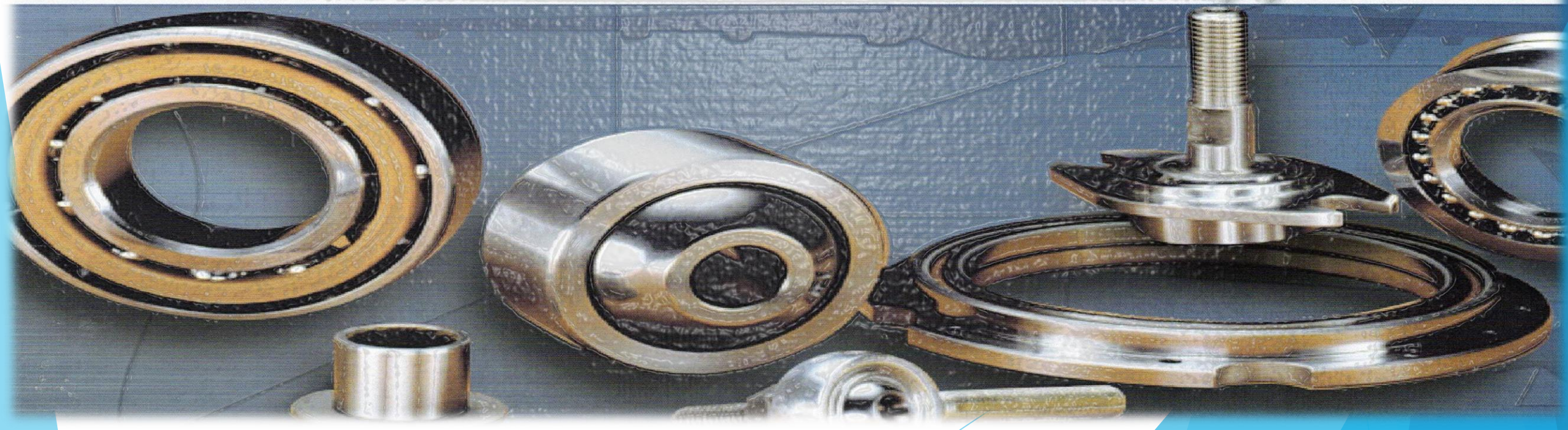

AEROSPACE & DEFENSE BEARINGS

IBSCO supports commercial and military airplanes as well as today's most innovative and high-tech helicopters. Providing standard and custom precision bearings for every aerospace bearing application.

OUR OFFER INCLUDES:

INSTRUMENT BEARINGS - Precision ABEC 7

AIRFRAME CONTROL BEARINGS - Plated & Precision

TRACK ROLLERS AND CAM FOLLOWERS

SPHERICAL PLAIN BEARINGS - PTFE lined, metal to metal & stainless steel

ROD END BEARINGS - PTFE lined, ball bearing type & stainless steel

JOURNAL BEARINGS - PTFE lined, stainless, aluminum & oil-impregnated bronze

CYLINDRICAL ROLLER BEARINGS - Ball and Roller type

THRUST REVERSER BEARINGS - High temp metals

LANDING GEAR BEARINGS - Sphericals, & Rod Ends

BSCO

Medical & Dental

Custom Solutions for Advanced Application

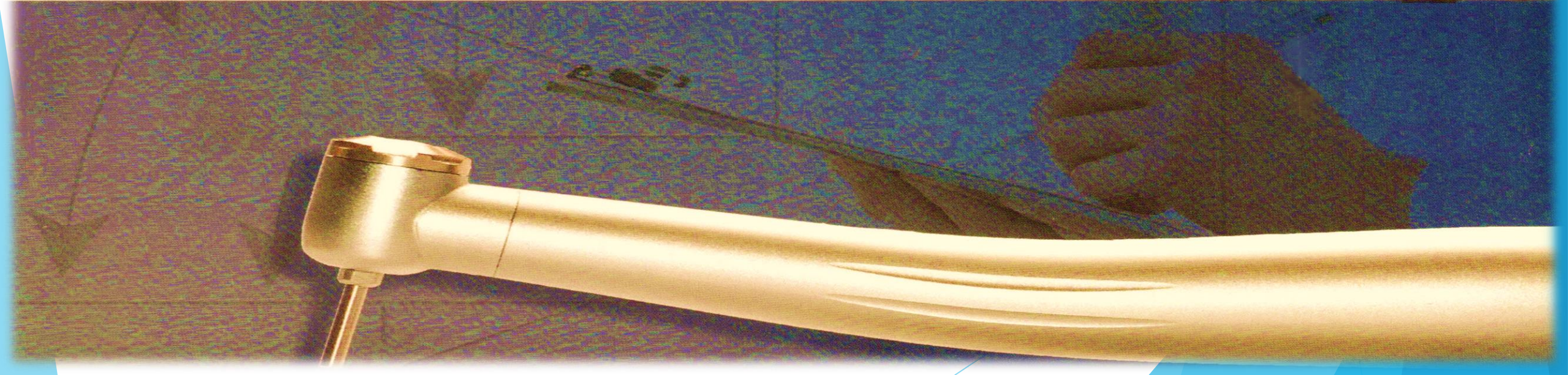

Medical & Dental

WE SUPPORT THE FOLLOWING DEVICE & HANDPIECE BRANDS:

BIEN AIR

CASTELLINI

DABI ATLANTE

KAVO

LARES

MICRO-AIRE

MIDWEST

MORITA

NSK

PALISADE

SIEMENS

SIRONA

STAR DENTAL

STRYKER

W&H

YOSHIDA

IBSCO Speciality Bearings & Assemblies

- Angular-contact and radial-contact types
- Extended life and performance
- Economical ceramic components - Balls & Rings
- High-Speed up to - 500K rpm
- Spindle assemblies
- Many support repeated exposure to an autoclave
- Highly finished ABEC 7/P4 precision rings, rolling elements, raceways and cage materials
- Machined cages - Phenolic, Polyamide-imide, Silver coated, Full type, Slug, Delrin[®], Meldin[®]
- Turbine assemblies

Delrin[®] is a registered trademark of DuPont
Meldin[®] is a trademark of Saint-Gobain

BESTORQ®

POWER TRANSMISSION PRODUCTS

See For Yourself The BESTORQ Difference!

Our X5 belts bring in a new generation of V-Belt performance. They are specially designed to use only 40% as much energy to bend around your machine's pulleys, and are proven to outlast the competition. Saving energy and keeping your machines running at full capacity means you save time and money.

- X5 belts are made with EPDM compound for improved belt life
- Temperature rating of -70°F to 260°F
- Meet all ARPM Belt Standards, are heat & oil resistant, and are Static Conducting to ARPM & Mine Safety Standards

BELT LIFE OF ALL MAJOR BRANDS

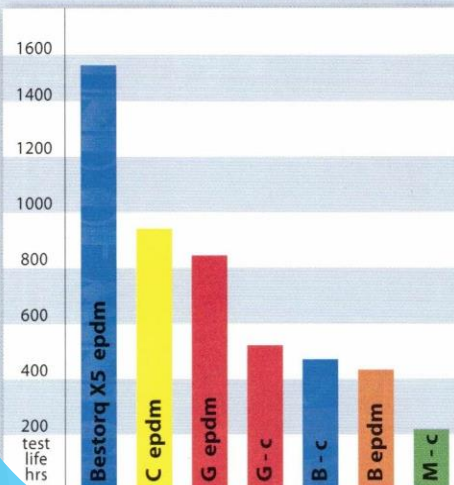

Bestorq 5VX530 X5 Belt Life Test Data

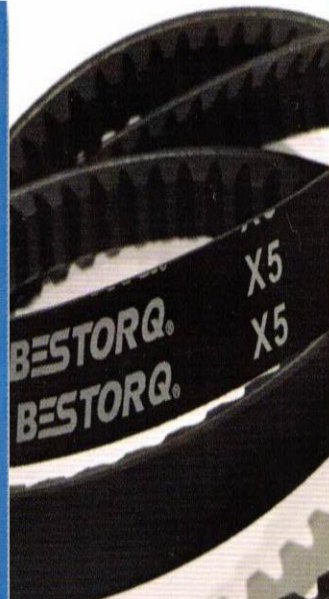

ENERGY LOSS OF V-BELTS FLEXING AROUND PULLEYS

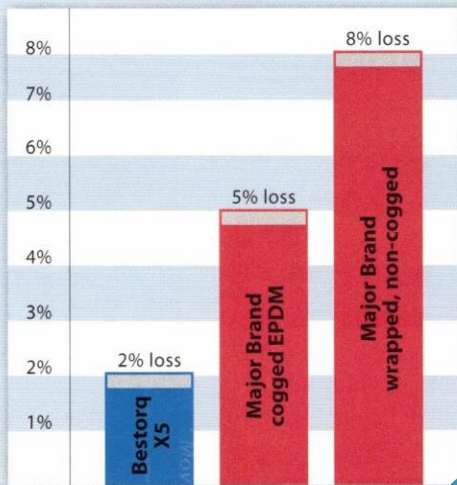

results based on 5.75" driver diameter, BX or P

Made In the USA,
BESTORQ is One of
The World's Leading
Belt Companies With
Best-In-Class Quality,
Uniformity &
Reliability That Equals
Continental Or Gates
While Offering Lower
Price Points with
Proven Success as The
OE Belt For Over 190
Manufacturers.

IBSCO Offers The Tools Necessary to Install and Remove Spherical Bearings in Standard or Custom Application Kits to Meet Your Specific Needs. Available in Drill Press and Portable Kit Configurations to Give You the Flexibility Needed to Get the Job Done Anywhere.

Bearing Tools & Kits for MS Series Bearing

MIL-B-81820		Tri-Roller		Cutter		Swaging Kit		Proof Load	
Bearing # (MS14101)	Bearing # (MS14103)	Drill Press Tool Model #	Portable Tool Model #	Drill Press Tool Model #	Portable Tool Model #	Drill Press Kit Model #	Portable Kit Model #	Drill Press Kit Model #	Portable Kit Model #

Housing Stake & Sleeve Swage

Other methods of bearing retention include staking the housing over the bearing or using a sleeve over the outer race and the housing. This can be accomplished with various methods including ball and segment impression staking using flat rollers.

Custom Staking Kits Tailored for Your Needs

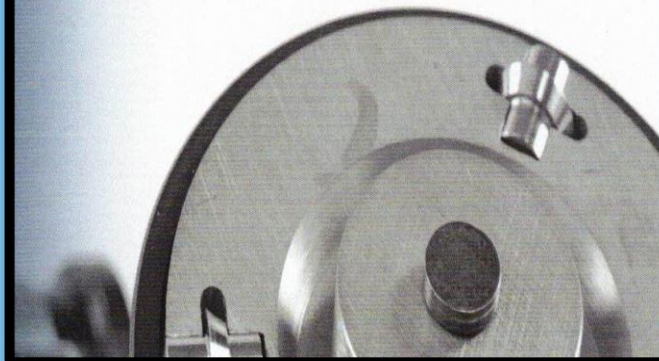

Custom Design Tools

Many custom designed tools exist or can be designed to meet your application. A complete bearing size description and housing as listed below and any clearance restrictions must be known for proper design.

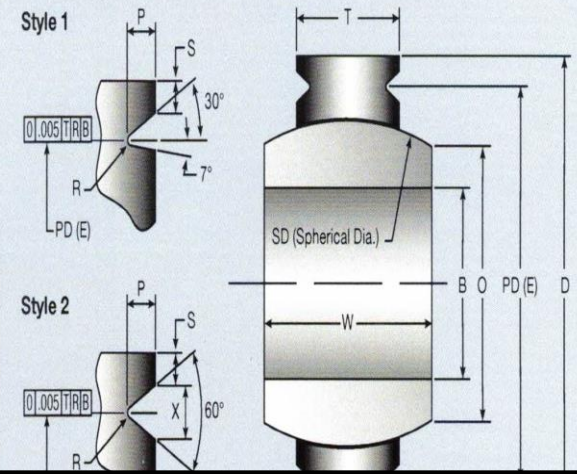

Take Advantage of Our Testing Tools to Perform Retention Inspections and Measure Breakaway Torque When The Job is Completed.

Value Added Services

- **State-of-the-Art ISO Class 7 Cleanroom**
 - ISO 14644-1:2015
- **Services that include:**
 - Lubrication to meet customer specifications
 - Lube fill rate down to fractions of a milligram
 - Vacuum Impregnation of phenolic cages
 - Enclosure re-configurations (seals and shields)
 - Re-lubrication of customer owned products
- **Kitting**
- **Customized packaging / labeling**





FACTORY AUTHORIZED Relubrication Facility

Precision lubrication fill to .0001 grams

Modification of standard bearings

Adding high-temp, low torque seals, teflons,
contact & non-contact rubber seals

Product Serialization, Linear and 2D bar coding

Vial, Strip, Pill Packaging & private brand labeling

Centrifuged oil re-lubrication

Vacuum Impregnation of Phenolic Retainers

Customer Specific Grease & Oil Plating

Relube and Refresh Expired Inventory

Extensive Range of Lubricants including food grade greases and oils

Government approved source for preservation & packaging per MIL-DTL-197



IBSC 
INTERCONTINENTAL BEARING SUPPLY COMPANY

Let IBSCO help with your bearing needs

- **Stocking programs designed to mitigate long lead times**
- **Long Term Pricing Agreements – Fixed & Firm Pricing**
- **Customized lubrication & Packaging – Quick turn times, Competitive pricing**
- **Total Cost of Ownership reduction – 100% Quality, On-Time Delivery, Scheduling Flexibility, Safety Stock and Hold for Release programs**



IBSCO
INTERCONTINENTAL BEARING SUPPLY COMPANY

Intercontinental Bearing Supply Co, Inc.
17711 Telge Road
Cypress, TX 77429

Small Business Concern
Veteran Owned
www.ibsco.com

Contact IBSCO'S
Regional Outside
Sales Specialist
Today For More
Information

Jason Martino-CPMR

Phone

(413) 627-1607

Email

jason.martino@ibsco.com

**Northeast Region – MA, NY,
CT, PA, NJ, ME, NH, RI, VT**